

Industrial IP65 600x600 - Wall mount



Polyurethane gasket in continuous casting to guarantee IP65 protection degree.

Earthing pins



Description

The IP65 Industrial Series is the ideal solution for wall-mount applications in many different sectors: industrial automation and control, power distribution, industrial electronics and data transmission. Designed to guarantee a high degree of IP protection, these cabinets are recommended for use in dusty environments or even where there are substances that could become potentially harmful once installed indoors.

Technical features

The exceptionally robust monoblock structure is made of welded 1.5 mm-thick steel sheet offering high protection degree. The door can be either blind or in tempered glass fitted with two locks with double-wing inprint. It is compliant to EN 60529 standard, thus offering IP65 degree of protection guaranteed by the polyurethane foam gasket in continuous casting.

Technical Specifications

Structure	Monoblock, Welded	Mounting	Wall or pole (brackets not included)
Material	1.5 mm steel sheet	Color	Epoxy powder Gray Polyester RAL 7035
Static load	100 kg	Protection degree	IP65 as per EN 60529
19" uprights	2 pcs, t=2.0 mm, 19" as per IEC 60297-1-2	Resistance degree	IK10 (blind), IK08 (glass) as per EN 62262
Blind door	1.5 mm steel sheet	Conformity	RoHS 2 Directive 2011/65 / EU
Glass door	Glass t=4.0 mm, tempered as per EN 12150-2	Certification	UL 508A / CSA C22.2 No. 14-13
Cable entry	Base with flange removable from the outside	Certification	CE as per EN62208
		Warranty	2 years

Industrial IP65 600x600 - Wall mount

Construction Drawing

- 1 Welded monobloc case
- 2 Bottom flange
- 3 Hinge
- 4 Blind or glass door
- 5 Bracket for wall mounting
- 6 Bracket for wall mounting
- 7 Support for 19" uprights
- 8 Depth-adjustable 19" uprights

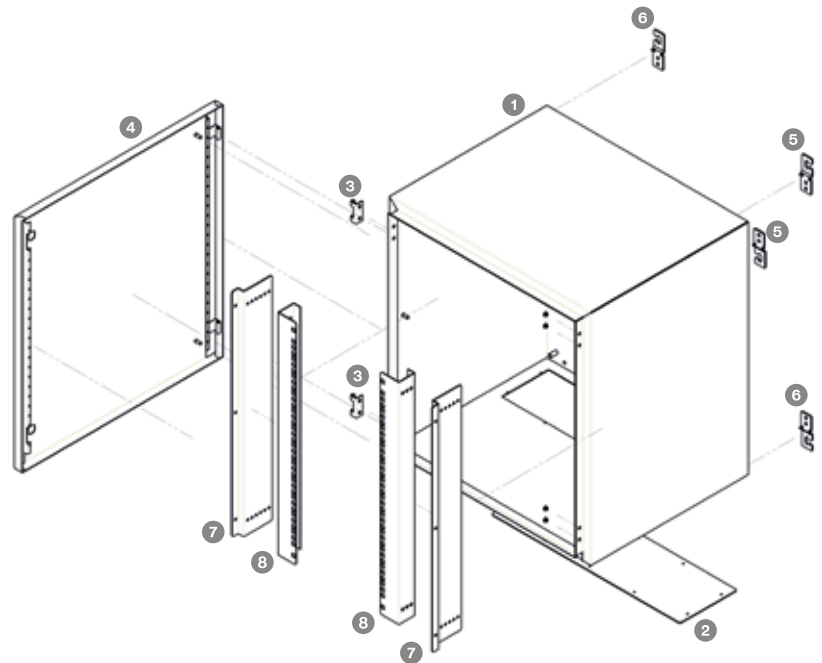

Versions

P/N	Description	Units	Height	Width	Depth	Color
309257	Industrial IP65 with blind door	9	500 mm	600 mm	600 mm	Grey, RAL 7035
309258	Industrial IP65 with blind door	12	650 mm	600 mm	600 mm	Grey, RAL 7035
309259	Industrial IP65 with blind door	16	850 mm	600 mm	600 mm	Grey, RAL 7035
309260	Industrial IP65 with glass door	9	500 mm	600 mm	600 mm	Grey, RAL 7035
309261	Industrial IP65 with glass door	12	650 mm	600 mm	600 mm	Grey, RAL 7035
309262	Industrial IP65 with glass door	16	850 mm	600 mm	600 mm	Grey, RAL 7035

Other dimensions and configurations are available on request.

Accessories

P/N	Description	Units	Width	Depth	Color
309249	Rain protection roof	/	/	/	Grey, RAL 7035
309263	Wall fixing brackets (pack of 4)	/	/	/	Galvanized
309256	Pole fixing kit	/	/	/	Galvanized